

TO :	 <b>Jinyoung Contech Co., Ltd.</b> #501, 222-12 MARIOTOWER, GURO-DONG, GURO-KU, SEOUL, KOREA TEL : 82-2-890-6400      FAX : 82-2-890-6406 HOME PAGE : <a href="http://www.jyct.com/">http://www.jyct.com/</a>	Issued Date : 2006-11-10 <hr/> Page : 13ages
<b>TFT LCD MONITOR INOV121-T"</b>		<b>USER'S MANUAL</b>

# INOV121-T

Ver10

**Revision History**

Date	Rev. No.	Contents	Remark
06. 11. 10	1.0	Initial	

**Table of Contents**

<b>1. Safety Precaution</b>	<b>4</b>
1.1 Set up and General Handling	4
Precaution	4
1.2 Operating Precaution	4
1.3 Cleaning of the equipment and management Precaution	
<b>2. Introduction</b>	<b>5</b>
<b>3. Specification</b>	<b>5</b>
Compatibility of Vertical Frequency	6
<b>4. Block Diagram</b>	<b>7</b>
<b>5. LCD DISPLAY SYSTEM setting up and how to adjustment</b>	<b>8</b>
<b>6. Connector</b>	<b>10</b>
<b>7. Dimensions</b>	<b>13</b>

## 1. Safety Precaution

The safety recommendations outlined in this section are to be read, understood and followed before operating the product. Keep this information in a safe place for future reference. Failure to comply with any of the following safety procedures could result in serious hazard.

### 1.1 Set up and General Handling Precaution

1. Please set up this equipment in clean area where there is no dust.
2. Do not set up the equipment on shaky stand, on incline surface or surfaces subject to frequent vibration.
3. This product is intended for indoor use only.
4. Do not press heavily the LCD panel with sharp objects, such as nails.
5. When set up the equipment, be extremely careful.  
You may get injured from the sharp parts, such as steel covers
6. When transporting the equipment, be extremely careful.
7. When transporting the equipment, hold the body with two hands letting LCD screen goes up.
8. Do not lift the equipment up holding LCD panel itself.
9. The Fluorescence lamp of LCD panel, this equipment, includes mercury.  
Do not waste or bury without leave. When waste, follow the related laws and regulations.

### 1.2 Operating Precaution

1. Do not place the equipment in areas subject to direct sunlight and close to heating elements.
2. Do not block ventilate openings. Fire may result due to the rising of the inner temperature.
3. Do not disassemble the back cover except a repairing engineer. This could result electrical shock
4. If you find any unusual action or break down while you using this equipment,  
unplug the DC power immediately and contact your retailer or Jinyoung Contech Support Help Desk.
5. Do not take apart or modify the equipment. Fire or electrical shock may result.
6. Do not spill liquids on the equipment. Do not set up in areas where there is high humidity and water splashes.
7. Do not plug in/unplug the DC power with wet hands. Fire or electrical shock may result.
8. Do not plug the equipment into outlets with voltage other than the specified voltage.  
Incorrect voltage may result in fire or electrical shock.
8. When unplugging the DC power, always pull on main body. Pulling on the cord may damage the wires and lead to fire or electrical shock.
9. Always plug the DC power in all the way. If it is not plugged in completely, fire or electrical shock may result.
10. When not in use for extended period, such as long weekend and moving the equipment,

unplug the DC power for safety. If dust accumulates in this area, it may result in fire.

11. Do not connect excessive numbers of plugs into one electrical outlet.

Fire or electrical shock may result.

12. The DC power is certain to be connected to electrical outlet that has an earth device.

13. Do not spill flammable liquid on the equipment. Fire or electrical shock may result.

14. Set up the outlet in areas where close to the equipment, easily accessible and easily operative.

### 1.3 Cleaning of the equipment and management Precaution

1. Do not take apart or modify the equipment. Fire or electrical shock may result.

2. When cleaning the equipment, always unplug the DC power.

3. When cleaning the equipment, do not use flammable liquids, such as alcohol, benzene or thinners.

4. If you strongly wipe down the surface of this equipment with a sponge and a piece of cloth, in case of plastic equipment, the coating may be fallen away.

5. When cleaning the equipment, use a water-moistened cloth that is well wrung out.

6. If the cleaning of the equipment inside necessary, contact Jinyoung Contech Support Help Desk.

## 2. Introduction

This unit is LCD monitor using TFT Color LCD. It basically supports Analog R,G,B signals, H-Sync, V-Sync.

This unit also supports DVI signal, CVBS 1 Channel and S-Video 1 Channel

This unit has OSD function for the best quality of display on characteristic of each VGA Card.

## 3. Specification

Panel	Item	Description
Features	Size	12.1"
	Resolution	XGA
	Pixel Format	1024(H) By 768(V)
	Pixel Pitch	0.240(H) x 0.240(W) (mm)
	Number of Colors	16.7 M (8-bit)
	Contrast Ratio	400 : 1 (Typ)
	Brightness	280 (cd/m <sup>2</sup> )
	Viewing Angle (U/D/L/R)	70/80/85/85
	Interface	LVDS
	Lamp Life Time	50,000 Hours
	Input Signal	PC Connectivity
Standard Input Source		DVI-I, CVBS 1 Channel S-VHS 1 Channel
Display	Functions	OSD Functions

ADAPTER	A.C Voltage Range	AC 100 ~ 240 VAC(50/60Hz)
	D.C Voltage Range	DC 12[V] 3.75[A]
Environmental Considerations	Storage Temperature	-20 ~ 60°C
	Operating Temperature	0 ~ 60°C
Dimensions	W x H x D	314 x 247 x 47 mm
Weight		Net ; 3.3 kg,

**Graphics input Modes supported**

Mode	Resolution	Horizontal freq.(KHz)	Vertical freq.(Hz)	Pixel Clock (MHz)
VESA MODES				
VGA	640 x 350 @85Hz	37.861	85.080	31.500
	640 x 400 @85Hz	37.861	85.080	31.500
	720 x 400 @85Hz	37.927	85.039	35.500
	640 x 480 @60Hz	31.469	59.940	25.175
	640x480@ 72 Hz	37.861	72.809	31.500
	640x480 @ 75 Hz	37.500	75.000	31.500
SVGA	800x600 @ 56 Hz	35.156	56.250	36.000
	800x600 @ 60 Hz	37.879	60.317	40.000
	800x600 @ 72 Hz	48.077	72.188	50.000
	800x600 @ 75 Hz	46.875	75.000	49.500
XGA	1024x768 @ 60 Hz	48.363	60.004	65.000
	1024x768 @ 70 Hz	56.476	70.069	75.000
	1024x768 @ 75 Hz	60.023	75.029	78.750
CVBS, S-VHS Input Modes				
NAME	TYPE	Vertical freq.(Hz)	CARRIER(MHz)	
PAL	B,G,H,I	50 Hz	4.433618	
NTSC	M	60 Hz	3.579545	
SECAM	SECAM	50 Hz	4.286	
NTSC44	NTSC44	60 Hz	4.433618	
PALM	M	60 Hz	3.575611	
PALN	N	50 Hz	3.582056	
PAL60	60	60 Hz	4.433618	

## 4. Block Diagram

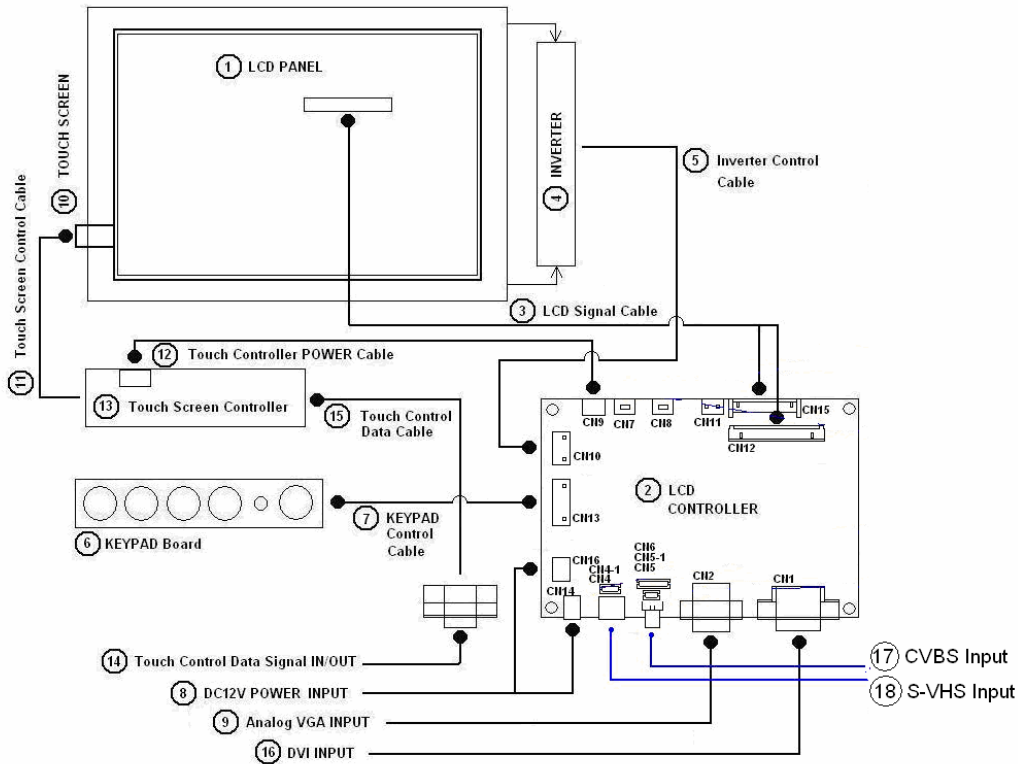

### Note

1. LCD PANEL
2. LCD CONTROLLER CARD, JY-TX520
3. LCD Signal Cable
4. Inverter for backlight
5. Inverter Cable
6. Keypad Board, Function Control
7. Keypad Control Cable
8. DC12V Power Input (Adaptor or Power Module)
9. PC Analog VGA Input
10. Touch Screen Panel
11. Touch Data Input Cable
12. Touch Power Support Cable(DC12V or DC5V)
13. Touch Controller
14. Touch Control DATA IN/OUT
15. Touch Controller Interface Cable
16. DVI Input
17. CVBS (Video) Input Board(Optional)
18. S-VHS (S-Video) Input (Option)

5. LCD DISPLAY SYSTEM setting up and adjustment

Controls	Description	HOT KEY Functions
On/Off	Board power on / off Control	
Menu	OSD Main Menu 실행 또는 해제 시	
SEL	Main item 또는 sub item 실행 시 또 선택 시	Inputs Souse (Select)
UP	Item up 방향 이동 시나 설정치 증가 시	AUTO (Analog Input Only)
DN	Item down 방향 이동 시나 설정치 감소 시	Brightness Control
HOT KEY Function은 OSD가 OFF인 상태에서 동작 합니다.		



OSD B'D R11

OSD Function

5.1 Input Select Items :





	1	PC Analog Input Select
	2	PC DVI Input Select
	3	S-Video Input Select
	4	composite Video Input Select
	5	Component Video Input Select ( <b>NOT Support</b> )

5.2 Brightness & Contrast .. Adjust Items :







		Adjust Brightness when PC Analog signals input.
		Adjust contrast when PC Analog signals input.
		Adjust Brightness when video signals input.
		Adjust contrast when video signals input.
		Adjust hue when video signals input.
		Adjust saturation when video signals input.
		Adjust definition of video image.







5.3 Color Adjust Items :

		Auto color adjustment
		sRGB color operating.
		Adjust the temperature of color.
		Adjust color mode.



5.4 Image Adjust Items :

		Auto adjust image.
		Adjust horizontal size of image.
		Adjust phase of image.
		Adjust the image horizontally.
		Adjust the image vertically.

5.5 Utility Items :

		Initialize.
		Adjust OSD menu.
		Adjust definition.
		DOS Mode . Control DOS mode.

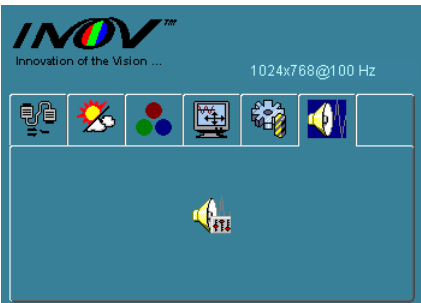
5.6 Audio Adjust Item :

		Volume control.

5.7 Warning Message item

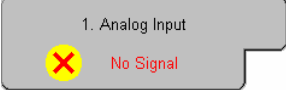
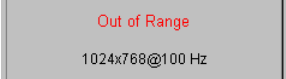
	No signal	When it doesn't get any signals, the message "No Signal " will display.
	Out of Range	When current PC VGA Signal resolution can't support input signal, the message "out of range" will display with current resolution information.

6. Connector

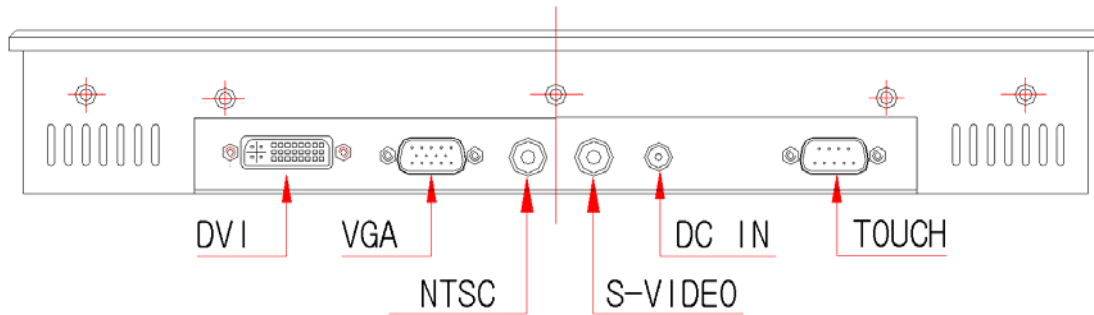

> DVI Input : JAE DV2R029N (Analog & Digital)

PIN	SYMBOL	DESCRIPTION
1	RX2-	T.M.D.S Data 2 -
2	RX2+	T.M.D.S Data 2 +
3	GND	Ground
4	NC	No connection
5	NC	No connection
6	SCL	DDC Clock
7	SDA	DDC Data
8	NC	No connection
9	RX1-	T.M.D.S Data 1 -
10	RX1+	T.M.D.S Data 1 +
11	GND	Ground
12	NC	No connection
13	NC	No connection
14	DVI_+5V	+5V Power
15	NC	No connection
16	Hot Plug	Hot Plug Detect
17	RX0-	T.M.D.S Data 0 -
18	RX0+	T.M.D.S Data 0 +
19	GND	Ground
20	NC	No connection
21	NC	No connection
22	GND	Ground
23	RXC+	T.M.D.S Clock +
24	RXC-	T.M.D.S Clock -
25/C1	NC	No connection
26/C2	NC	No connection
27/C3	NC	No connection
28/C4	NC	No connection
29/C5	GND	Analog ground
30/C5	GND	Analog ground

➤ **VGA analog Input** : DB-15 way high density 3 row

PIN	SYMBOL	DESCRIPTION
1	RED	Red, analog
2	GREEN	Green, analog
3	BLUE	Blue, analog
4	NC	No connection
5	CHK_CBL	VGA cable connection check
6	AGND	Analog ground red
7	AGND	Analog ground green
8	AGND	Analog ground blue
9	DDC5V	+5V power supply for DDC (optional)
10	GND	Digital ground
11	NC	No connection
12	D_SDA	DDC serial data
13	HS_IN	Horizontal sync or composite sync, input
14	VS_IN	Vertical sync, input
15	D_SCL	DDC serial clock

➤ **CVBS(NTSC) Input** : RCA Right Angle (Yellow)

PIN	SYMBOL	DESCRIPTION
1	CVBS	Composite Video Signal Input
2	GND	Ground

➤ **S-VHS Input** : Mini-Din 4pin

PIN	SYMBOL	DESCRIPTION
1	S-C_IN	Chroma Signal Input
2	GND	Ground
3	GND	Ground
4	S_Y_IN	Luminance Signal Input

➤ **Power** : DC 12[V] Input Jack



DC JACK	Description
+	DC 12V
-	Ground

PIN	DESCRIPTION
+	+ 12VDC In
-	Ground

➤ **Touch Rs232 port** : DB-15 way high density 2 row

Pin	Signal	Pin	Signal
1	N.C	6	DSR
2	TXD0( To PC RXD Pin)	7	RTS
3	RXD0( To PC TXD Pin)	8	N.C
4	DTR	9	N.C
5	Ground		

7. Dimensions

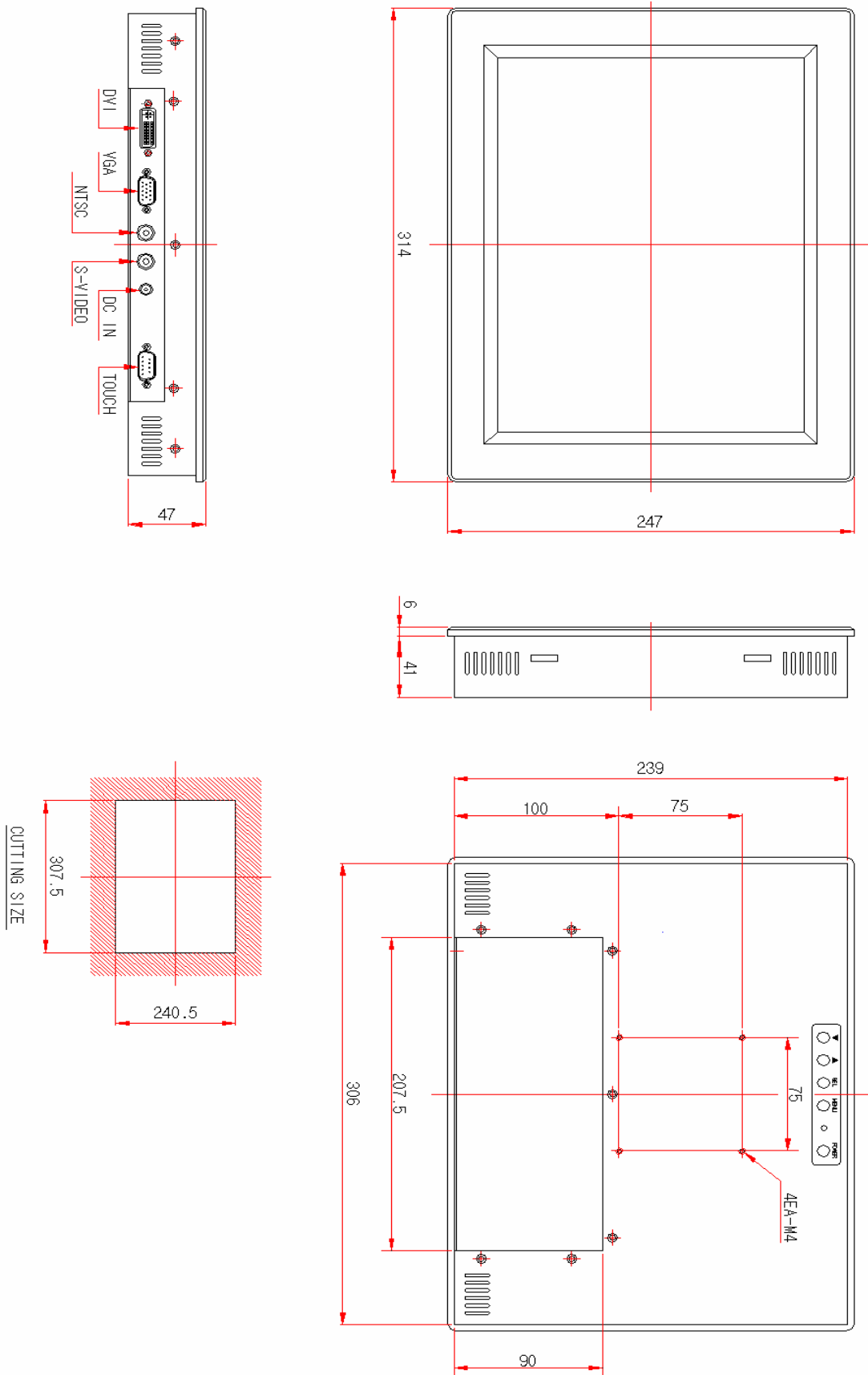

VESA standard 75 x 75mm holes for LCD monitor arm